



VRx and AXON™ Winch Rope Installation Instructions



Always Read All Product Literature **BEFORE** installing product.
Toujours lire toute la documentation produit **AVANT** d'installer le produit.
Siempre lea toda la literatura del producto **ANTES** de instalar el producto

www.warn.com

ITEMS NEEDED/ ÉLÉMENTS NÉCESSAIRES/ ELEMENTOS NECESARIOS

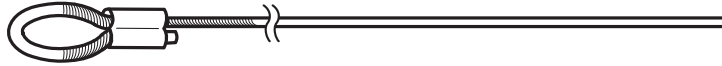

INSTALLATION/ INSTALACIÓN



1.

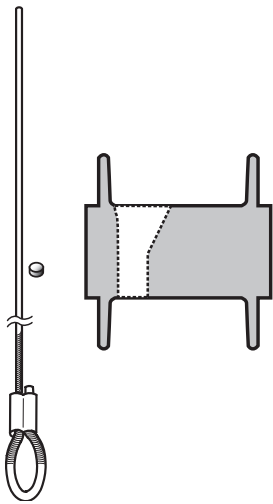

2.

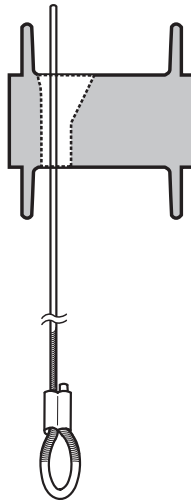

3.

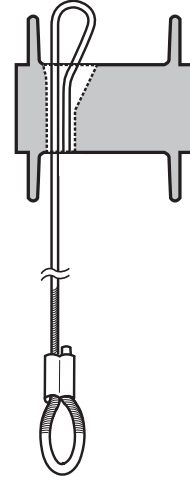

4.

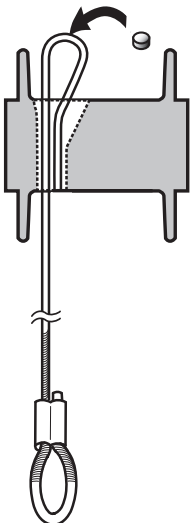

5.

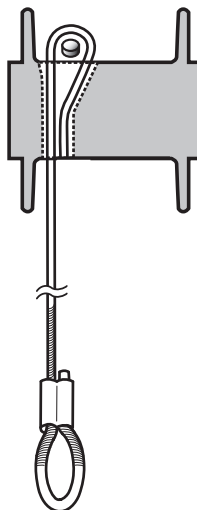

6.

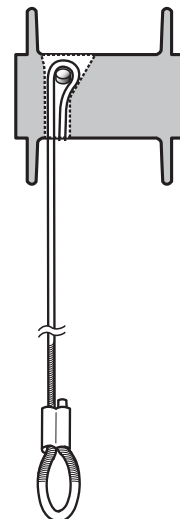

7.

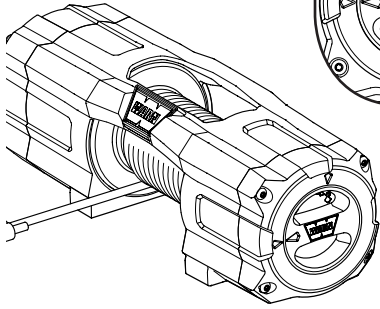
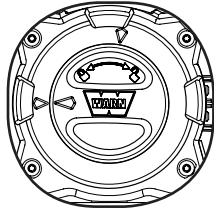

8.

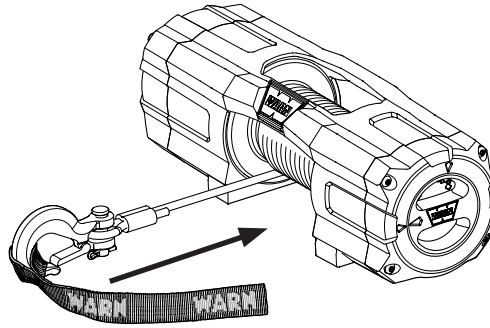

9.

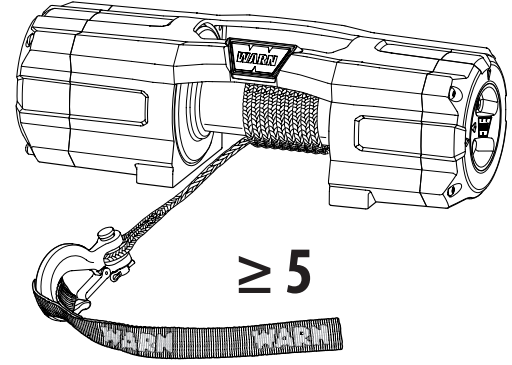

- **Always** know the Working Load Limit (WLL) of your rope. / **Toujours** déterminer si le câble est adapté à l'application envisagée. / Verifique **siempre** que el cable sea apto para cada aplicación.
- **Never** exceed the WLL (Working Load Limit) of rope or shock load this rope. / **Ne jamais** dépasser la limite de charge de service (LCS) du câble ou secouer le câble sous charge / No exceda **nunca** el límite de carga de trabajo ni cargue bruscamente este cable.

Rope Size/ Dimension de câble / Tamaño del cable

Working Load Limit / Charge utile / Límite de carga de trabajo

WIRE

3/16" (4.8 mm)

2500 lb. (1134 kg)

7/32" (5.6 mm)

3500 lb. (1588 kg)

1/4" (6.3 mm)

5500 lb. (2495 kg)

SYNTHETIC

3/16" (4.8 mm)

3500 lb. (1588 kg)

1/4" (6.3 mm)

5500 lb. (2041 kg)



(Deutsch) Bitte besuchen www.warn.com für Installationsanleitung.

(Svenska) Besök www.warn.com för Installera instruktioner.

(Italiano) Visitare www.warn.com per installare istruzioni.

(Suomi) Vieraille www.warn.com asennusohje.

(Nederlands) Bezoek www.warn.com voor installatiehandleiding.

(Português) Visite www.warn.com para guia de instalação.

WARN INDUSTRIES, INC. 12900 S.E. Capps Road, www.warn.com
 Clackamas, OR USA 97015-8903, 1-503-722-1200, FAX: 1-503-722-3000
 Customer Service: 1-800-543-9276
 Dealer Locator Service: 1-800-910-1122
 International Fax: 1-503-722-3005